

# OLED DISPLAY MODULE

## Product Specification

<b>CUSTOMER</b>	<b>Standard</b>	
<b>PRODUCT NUMBER</b>	<b>DD-12864YO-3A</b>	
<b>CUSTOMER APPROVAL</b>		<b>Date</b>

INTERNAL APPROVALS		
Product Mgr	Doc. Control	Electr. Eng
<b>Bazile Peter</b>	<b>Bazile Peter</b>	<b>Luo LUO</b>
Date: 29 Jul 10	Date: 29 Jul 10	Date: 29 Jul 10

# TABLE OF CONTENTS

<b>1</b>	<b>MAIN FEATURES .....</b>	<b>4</b>
<b>2</b>	<b>MECHANICAL SPECIFICATION .....</b>	<b>5</b>
2.1	MECHANICAL CHARACTERISTICS .....	5
2.2	MECHANICAL DRAWING .....	6
<b>3</b>	<b>ELECTRICAL SPECIFICATION.....</b>	<b>7</b>
3.1	ABSOLUTE MAXIMUM RATINGS .....	7
3.2	ELECTRICAL CHARACTERISTICS .....	8
3.3	INTERFACE PIN ASSIGNMENT .....	9
3.4	BLOCK DIAGRAM .....	11
3.5	TIMING CHARACTERISTICS .....	12
<b>4</b>	<b>OPTICAL SPECIFICATION.....</b>	<b>16</b>
4.1	OPTICAL CHARACTERISTICS .....	16
<b>5</b>	<b>FUNCTIONAL SPECIFICATION .....</b>	<b>17</b>
5.1	COMMANDS .....	17
5.2	POWER UP/DOWN SEQUENCE.....	17
5.3	RESET CIRCUIT .....	17
5.4	ACTUAL APPLICATION EXAMPLE .....	18
<b>6</b>	<b>PACKAGING AND LABELLING SPECIFICATION.....</b>	<b>19</b>
<b>7</b>	<b>QUALITY ASSURANCE SPECIFICATION .....</b>	<b>20</b>
7.1	CONFORMITY .....	20
7.2	DELIVERY ASSURANCE .....	20
7.3	DEALING WITH CUSTOMER COMPLAINTS .....	24
<b>8</b>	<b>RELIABILITY SPECIFICATION .....</b>	<b>25</b>
8.1	RELIABILITY TESTS .....	25
8.2	LIFE TIME.....	25
<b>9</b>	<b>HANDLING PRECAUTIONS.....</b>	<b>26</b>
<b>10</b>	<b>SUPPORTED ACCESSORIES .....</b>	<b>27</b>
10.1	DUO KIT.....	27
10.2	TRANSITION BOARD CARD .....	27
10.3	CONNECTOR BOARD CARD.....	27
10.4	CONNECTOR .....	27

Product No.	DD-12864YO-3A	REV. D

Page	2 / 27
------	--------

REVISION RECORD

Rev.	Date	Page	Chapt.	Comment	ECR no.
A	12 Nov 07			First Issue	
B	10 June 10	6 7 16 18 25 25	2.2 3.1 4.1 5.4 8.1 8.2	Mechanical Drawing Absolute maximum Rating Optical characteristics Actual application examples Reliability test Life time	
C	29 Jul 10	25	8.2	Life time (typing error)	
D	28 Nov 12	27	10	Add chapter 10 supported accessories	

Product No.	DD-12864YO-3A	REV. D

Page	3 / 27
------	--------

# 1 MAIN FEATURES

ITEM	CONTENTS
Display Format	128 x 64 Dots
Overall Dimensions	45.24 x 29.14 x 2.00 mm
Colour	Monochrome Yellow
Active Area	35.056 x 17.52 mm
Viewing Area	37.056 x 19.52 mm
Display Mode	Passive Matrix (1.54")
Driving Method	1/64 duty
Driver IC	SSD1305
Operating temperature	-30 ~ +70
Storage temperature	-40 ~ +80

Product No.	DD-12864YO-3A	REV. D

Page	4 / 27
------	--------

## 2 MECHANICAL SPECIFICATION

### 2.1 MECHANICAL CHARACTERISTICS

ITEM	CHARACTERISTIC	UNIT
Display Format	128 x 64 Dots	Dots
Overall Dimensions	45.24 x 29.14 x 2.00	mm
Viewing Area	37.056 x 19.52	mm
Active Area	35.056 x 17.52	mm
Dot Size	0.258 x 0.258	mm
Dot Pitch	0.274 x 0.274	mm
Weight	5.4	g
IC Controller/Driver	SSD1305	

Product No.	DD-12864YO-3A	REV. D

Page	5 / 27
------	--------

## 2.2 MECHANICAL DRAWING

Item	Date	Remark
A	20070920	Original Drawing
B	20091214	Change Protective Tape Material

Pin	Symbol	Pin Number
1	VCC	(08D)
2	VSS	(08D)
3	VSS	
4	VSS	
5	VSS	
6	BS1	
7	BS2	
8	RESA	
9	RESB	
10	RES	
11	RES	
12	RES	
13	RES	
14	RES	
15	RES	
16	RES	
17	RES	
18	RES	
19	RES	
20	RES	
21	RES	
22	RES	
23	RES	
24	RES	
25	RES	
26	RES	
27	RES	
28	RES	
29	RES	
30	RES	
31	RES	
32	VCC	(08D)
33	VCC	(08D)
34	VCC	(08D)

**Notes:**

- Color: Yellow
- Driver IC: SSD1305
- FPC Number: UT-0205-P05
- Interface:
- 8-bit 08XXX 80XXX Parallel, 4-wire SPI, I2C
- General Tolerance: ±0.30
- The total thickness (2-10 Max) is without polarizer protective film & remove tape. The actual assembled total thickness with above materials should be 2.35 Max.

Customer Approval Signature		DENSITRON DISPLAYS				Rev.
		Unit	mm	Title	Material	B
		Unless Otherwise Specified				
		General Roundness: $\phi$				
		Tolerance	±0.3	Panel / E.	P.M.	
		Dimension	±1	Drawn	20091214	20091214
		Angle	±1	By	20091214	20091214
				Date	20091214	20091214
				Scale	1:1	1 of 1
				Sheet		A3
				Size		

Product No.	DD-12864YO-3A	REV. D
-------------	---------------	--------

Page	6 / 27
------	--------

### 3 ELECTRICAL SPECIFICATION

#### 3.1 ABSOLUTE MAXIMUM RATINGS

VSS = 0 V, Ta = 25 °C

Item	Symbol	Min	Max	Unit	Note
Supply Voltage for logic	V <sub>DD</sub>	-0.3	4.0	V	Note 1, 2
Supply voltage for Display	V <sub>CC</sub>	0	15	V	
Operating Temperature	Top	-30	85	°C	
Storage Temperature	Tst	-40	90	°C	
Life Time (150 cd/m <sup>2</sup> )		10,000		Hour	
Life Time (100 cd/m <sup>2</sup> )		40,000		Hour	
Static Electricity	Be sure that you are grounded when handling displays.				

Note 1: All the above voltages are on the basis of “GND=0V”.

Note 2: When this module is used beyond the above absolute maximum ratings, permanent damage to the module may occur. Also for normal operations it’s desirable to use this module under the conditions according to Section 3.2 “Electrical Characteristics”. If this module is used beyond these conditions the module may malfunction and the reliability could deteriorate.

Note 3: V<sub>CC</sub> = 12.5V, T<sub>a</sub> = 25°C, 50% Checkerboard.

Software configuration follows Section 5.4 Initialization.

End of lifetime is specified as 50% of initial brightness reached. The average operating lifetime at room temperature is estimated by the accelerated operation at high temperature conditions.

Product No.	DD-12864YO-3A	REV. D

Page	7 / 27
------	--------

### 3.2 ELECTRICAL CHARACTERISTICS

Characteristics	Symbol	Conditions	Min	Typ	Max	Unit
Supply Voltage	V <sub>DD</sub>		2.4	2.8	3.5	V
Supply Voltage for Display	V <sub>CC</sub>	Note 3	12	12.5	13.0	V
High Level Input	V <sub>IH</sub>	I <sub>OUT</sub> =0.1mA, 3.3MHz	0.8xV <sub>DD</sub>	-	V <sub>DD</sub>	V
Low Level Input	V <sub>IL</sub>		0	-	0.2 x V <sub>DD</sub>	V
High Level Output	V <sub>OH</sub>		0.9 x V <sub>DD</sub>	-	V <sub>DD</sub>	V
Low Level Output	V <sub>OL</sub>		0	-	0.1 x V <sub>DD</sub>	V
Operating current for V <sub>DD</sub>	I <sub>DD</sub>	Note 4	-	180	300	μA
		Note 5	-	180	300	
Operating current for V <sub>CC</sub>	I <sub>CC</sub>	Note 4	-	20	25	mA
		Note 5	-	30	38	
Sleep mode current for V <sub>DD</sub>	I <sub>DD SLEEP</sub>		-	1	5	μA
Sleep mode current for V <sub>CC</sub>	I <sub>CC SLEEP</sub>		-	2	10	μA

Note 3 Brightness (L<sub>br</sub>) and Supply Voltage for Display (V<sub>CC</sub>) are subject to the change of the panel characteristics and the customer's request

Note 4 V<sub>DD</sub> = 2.8V, V<sub>CC</sub> = 12.5V, 50% display area turned on.

Note 5 V<sub>DD</sub> = 2.8V, V<sub>CC</sub> = 12.5V, 100% display area turned on.

Product No.	DD-12864YO-3A	REV. D

Page	8 / 27
------	--------



### 3.3 INTERFACE PIN ASSIGNMENT

No.	Symbol	Function															
1	N.C.(GND)	<b>Reserved Pin (Supporting Pin)</b> The supporting pins can reduce the influences from stresses on the function pins. These pins must be connected to external ground.															
2	VLSS	<b>Ground of Analog Circuit</b> This is an analog ground pin. It should be connected to VSS externally															
3	VSS	<b>Ground of OEL System</b> This is a ground pin. It also acts as a reference for the logic pins, the OEL driving voltages, and the analog circuits. It must be connected to external ground.															
4	N.C.	<b>No Connection</b>															
5	VDD	<b>Power Supply for Logic Circuit</b> This is a voltage supply pin. It must be connected to external source.															
6	BS1	<b>Communicating Protocol Select</b> These pins are MCU interface selection input. See the following table: <table border="1" data-bbox="539 846 1078 936"> <thead> <tr> <th></th> <th>68XX-parallel</th> <th>80XX-parallel</th> <th>Serial</th> <th>I2C</th> </tr> </thead> <tbody> <tr> <td>BS1</td> <td>0</td> <td>1</td> <td>0</td> <td>1</td> </tr> <tr> <td>BS2</td> <td>1</td> <td>1</td> <td>0</td> <td>0</td> </tr> </tbody> </table>		68XX-parallel	80XX-parallel	Serial	I2C	BS1	0	1	0	1	BS2	1	1	0	0
	68XX-parallel		80XX-parallel	Serial	I2C												
BS1	0	1	0	1													
BS2	1	1	0	0													
7	BS2																
8	CS#	<b>Chip Select</b> This pin is the chip select input. The chip is enabled for MCU communication only when CS# is pulled low.															
9	RES#	<b>Power Reset for Controller and Driver</b> This pin is reset signal input. When the pin is low, initialization of the chip is executed.															
10	D/C#	<b>Data/Command Control</b> This pin is Data/Command control pin. When the pin is pulled high, the input at D7~D0 is treated as display data. When the pin is pulled low, the input at D7~D0 will be transferred to the command register. For detail relationship to MCU interface signals, please refer to the Timing Characteristics Diagrams. When the pin is pulled high and serial interface mode is selected, the data at SDIN is treated as data. When it is pulled low, the data at SDIN will be transferred to the command register. In I2C mode, this pin acts as SA0 for slave address selection.															
11	R/W#	<b>Read/Write Select or Write</b> This pin is MCU interface input. When interfacing to a 68XX-series microprocessor, this pin will be used as Read/Write (R/W#) selection input. Pull this pin to "High" for read mode and pull it "Low" for write mode. When 80XX interface mode is selected, this pin will be the Write (WR#) input. Data write operation is initiated when this pin is pulled low and the CS# is pulled low.															
12	E/RD#	<b>Read/Write Enable or Read</b> This pin is MCU interface input. When interfacing to a 68XX-series microprocessor, this pin will be used as the Enable (E) signal. Read/write operation is initiated when this pin is pulled high and the CS# is pulled low. When connecting to an 80XX-microprocessor, this pin receives the Read (RD#) signal. Data read operation is initiated when this pin is pulled low and CS# is pulled low.															
13~20	D0~D7	<b>Host Data Input/Output Bus</b> These pins are 8-bit bi-directional data bus to be connected to the microprocessor's data bus. When serial mode is selected, D1 will be the serial data input SDIN and D0 will be the serial clock input SCLK. When I2C mode is															

Product No.	DD-12864YO-3A	REV. D

Page	9 / 27
------	--------

		selected, D2 & D1 should be tied together and serve as SDAout &SDAin in application and D0 is the serial clock input SCL.
21	IREF	<b>Current Reference for Brightness Adjustment</b> This pin is segment current reference pin. A resistor should be connected between this pin and VSS. Set the current lower than 10uA

22	VCOMH	<b>Voltage Output High Level for COM signal</b> This pin is the input pin for the voltage output high level for COM signals. A capacitor should be connected between this pin and VSS.
23	VCC	<b>Power Supply for OEL Panel</b> This is the most positive voltage supply pin of the chip. It can be supplied externally or generated internally by using internal DC/DC voltage converter.
24	N.C.(GND)	<b>Reserved Pin (Supporting Pin)</b> The supporting pins can reduce the influences from stresses on the function pins. These pins must be connected to external ground.

Product No.	DD-12864YO-3A	REV. D

Page	10 / 27
------	---------

### 3.4 BLOCK DIAGRAM

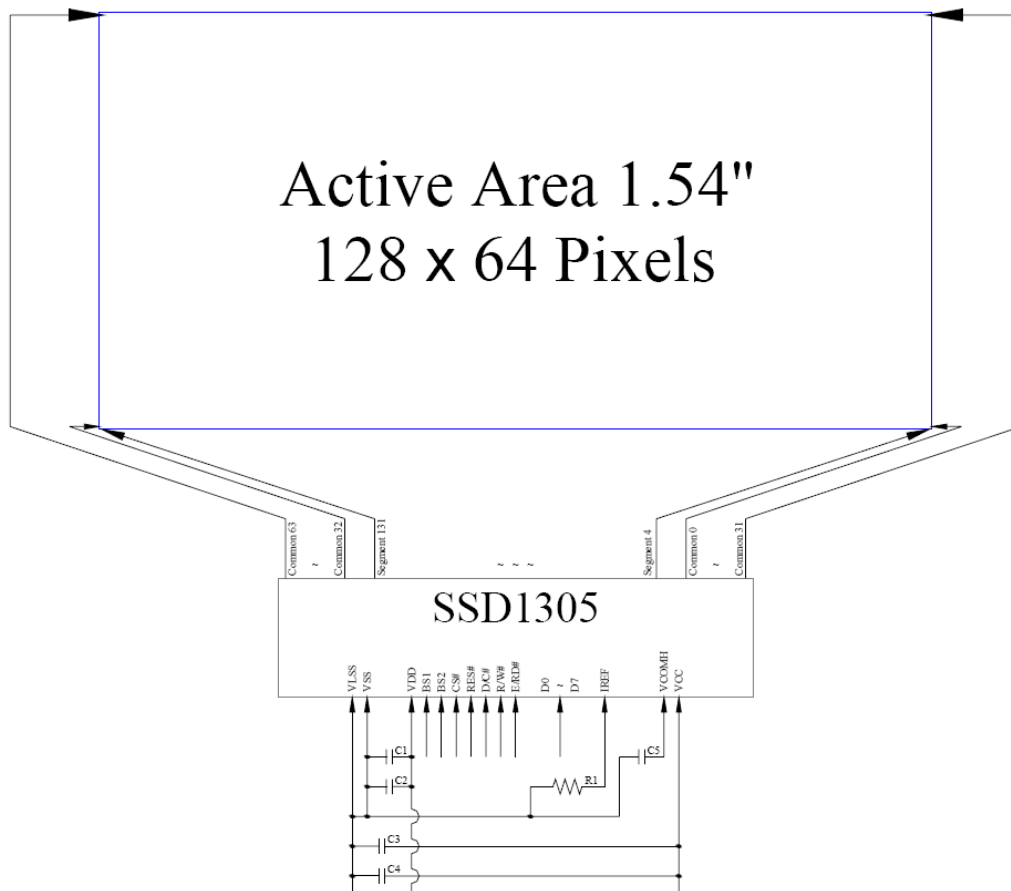

MCU Interface Selection: BS1 and BS2

Pins connected to MCU interface: D7~D0, E/RD#, R/W#, D/C#, RES# and CS#.

- C1, C3: 0.1 $\mu$ F
- C2: 4.7 $\mu$ F
- C4: 10 $\mu$ F
- C5: 4.7 $\mu$ F/25V Tantalum Capacitor
- R1: 910 k $\Omega$ ,  $R1 = (\text{Voltage at IREF} - \text{BGGND}) / \text{IREF}$

Product No.	DD-12864YO-3A	REV. D

Page	11 / 27
------	---------

### 3.5 TIMING CHARACTERISTICS

#### 3.5.1 AC CHARACTERISTICS

##### 3.5.1.1 68XX-Series MPU Parallel Interface Timing Characteristics

VDD = 2.8V, Ta = 25°C

Symbol	Description	Min	Max	Unit
t <sub>cycle</sub>	System Cycle Time	300	-	ns
t <sub>AS</sub>	Address Setup Time	0	-	ns
t <sub>AH</sub>	Address Hold Time	0	-	ns
t <sub>DSW</sub>	Write Data Setup Time	40	-	ns
t <sub>DHW</sub>	Write Data Hold Time	7	-	ns
t <sub>DHR</sub>	Read Data Hold Time	20	-	ns
t <sub>OH</sub>	Output Disable Time	-	70	ns
t <sub>ACC</sub>	Access Time	-	140	ns
PWCSL	Chip Select Low Pulse Width (Read) Chip Select	120	-	ns
	Low Pulse width (Write)	60		
PWCSH	Chip Select High Pulse Width (Read) Chip Select	60	-	ns
	High Pulse Width (Write)	60		
t <sub>R</sub>	Rise Time	-	15	ns
t <sub>F</sub>	Fall Time	-	15	ns

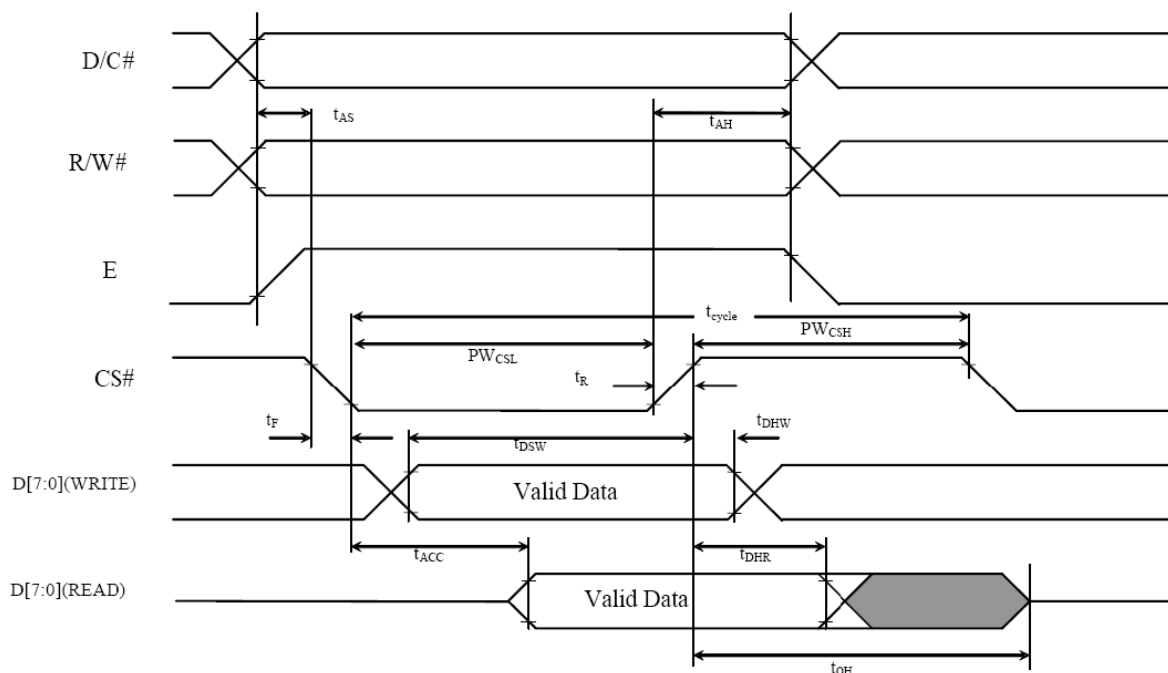

Product No.	DD-12864YO-3A	REV. D

Page	12 / 27
------	---------

### 3.5.1.2 8080-Series MPU Parallel Interface Timing Characteristics

Symbol	Description	Min	Max	Unit
t <sub>cycle</sub>	Clock Cycle Time	300	-	ns
t <sub>AS</sub>	Address Setup Time	10	-	ns
t <sub>AH</sub>	Address Hold Time	0	-	ns
t <sub>DSW</sub>	Write Data Setup Time	40	-	ns
t <sub>DHW</sub>	Write Data Hold Time	7	-	ns
t <sub>DHR</sub>	Read Data Hold Time	20	-	ns
t <sub>OH</sub>	Output Disable Time	-	70	ns
t <sub>ACC</sub>	Access Time	-	140	ns
t <sub>PWLR</sub>	Read Low Time	120	-	ns
t <sub>PWLW</sub>	Write Low Time	60	-	ns
t <sub>PWHR</sub>	Read High Time	60	-	ns
t <sub>PWHW</sub>	Write High Time	60	-	ns
t <sub>CS</sub>	Chip Select Setup Time	0	-	ns
t <sub>CSH</sub>	Chip Select Hold Time to Read Signal	0	-	ns
t <sub>CSF</sub>	Chip Select Hold Time	20	-	ns
t <sub>R</sub>	Rise Time	-	15	ns
t <sub>F</sub>	Fall Time	-	15	ns

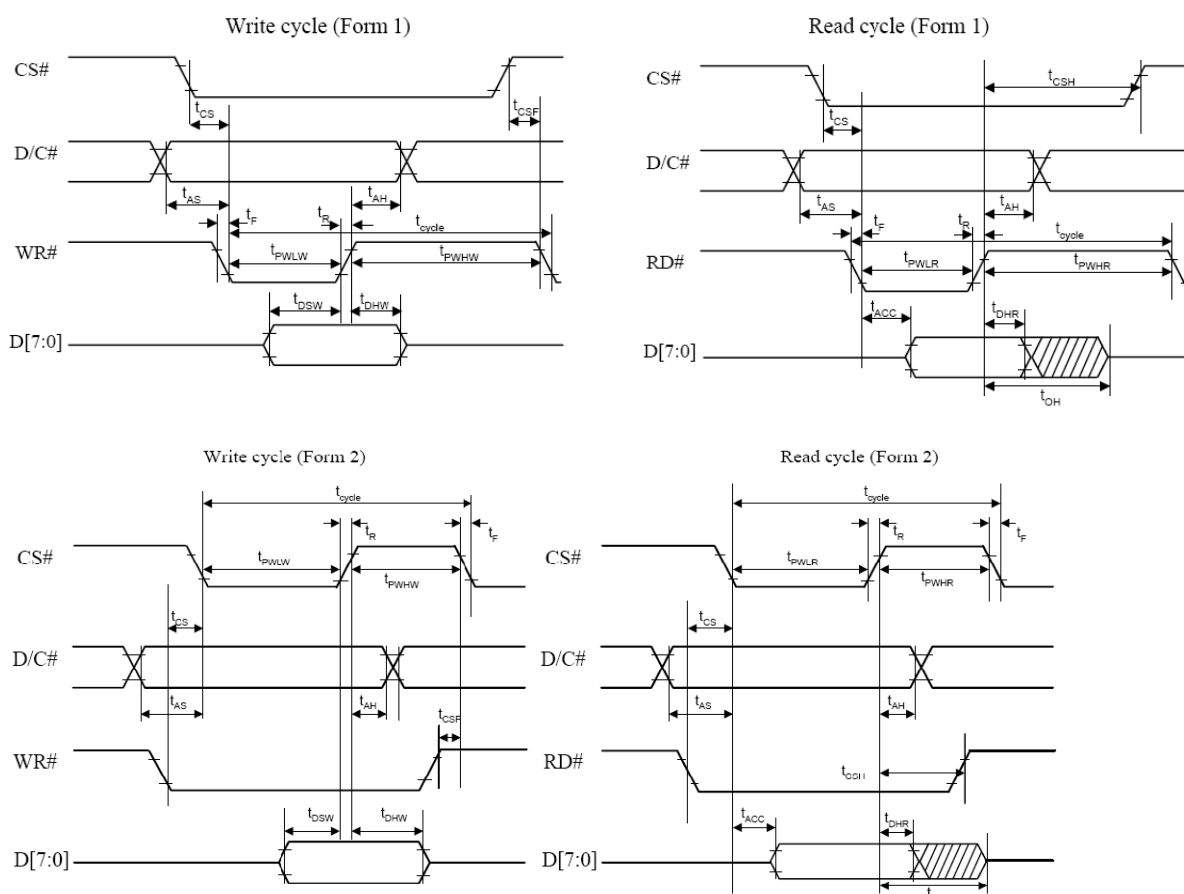

Product No.	DD-12864YO-3A	REV. D
-------------	---------------	--------

Page	13 / 27
------	---------

### 3.5.1.3 Serial Interface Timing Characteristics

VDD = 2.8V , Ta = 25°C

Symbol	Description	Min	Max	Unit
t <sub>cycle</sub>	Clock Cycle Time	250	-	ns
t <sub>AS</sub>	Address Setup Time	150	-	ns
t <sub>AH</sub>	Address Hold Time	150	-	ns
t <sub>CSS</sub>	Chip Select Setup Time	120	-	ns
t <sub>CSH</sub>	Chip Select Hold Time	60	-	ns
t <sub>DSW</sub>	Write Data Setup Time	50	-	ns
t <sub>DHW</sub>	Write Data Hold Time	15	-	ns
t <sub>CLKL</sub>	Serial Clock Low Time	100	-	ns
t <sub>CLKH</sub>	Serial Clock High Time	100	-	ns
t <sub>R</sub>	Rise Time	-	15	ns
t <sub>F</sub>	Fall Time	-	15	ns

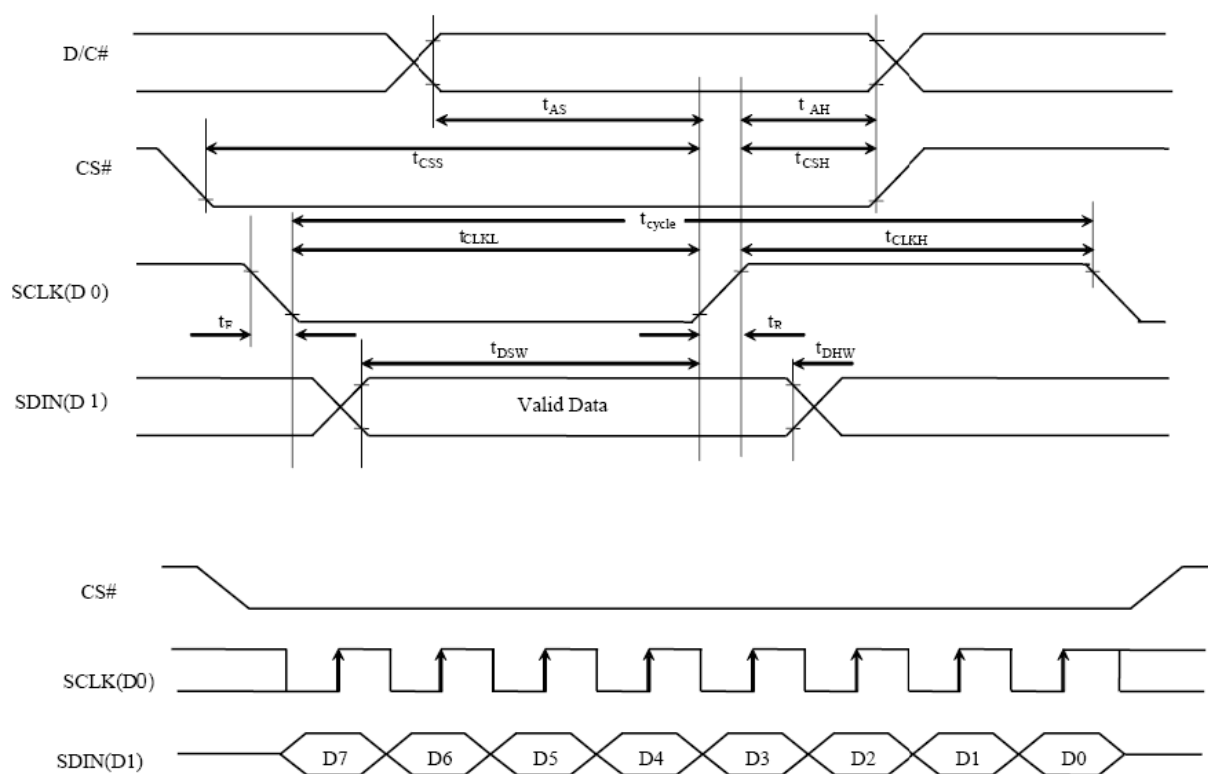

Product No.	DD-12864YO-3A	REV. D

Page	14 / 27
------	---------

### 3.5.1.4 I<sup>2</sup>C Interface Timing Characteristics

Symbol	Description	Min	Max	Unit
t <sub>cycle</sub>	Clock Cycle Time	2.5	-	us
t <sub>HSTART</sub>	Start Condition Hold Time	0.6	-	us
t <sub>HD</sub>	Data Hold Time (for “SDAOUT” Pin) Data	0	-	ns
	Hold Time (for “SDAIN” Pin)	300		
t <sub>SD</sub>	Data Setup Time	100	-	ns
	Start Condition Setup Time			
t <sub>SSTART</sub>	(Only relevant for a repeated Start condition)	0.6	-	us
t <sub>SSTOP</sub>	Stop Condition Setup Time	0.6	-	us
t <sub>R</sub>	Rise Time for Data and Clock Pin		300	ns
t <sub>F</sub>	Fall Time for Data and Clock Pin		300	ns
t <sub>IDLE</sub>	Idle Time before a New Transmission can Start	1.3	-	us

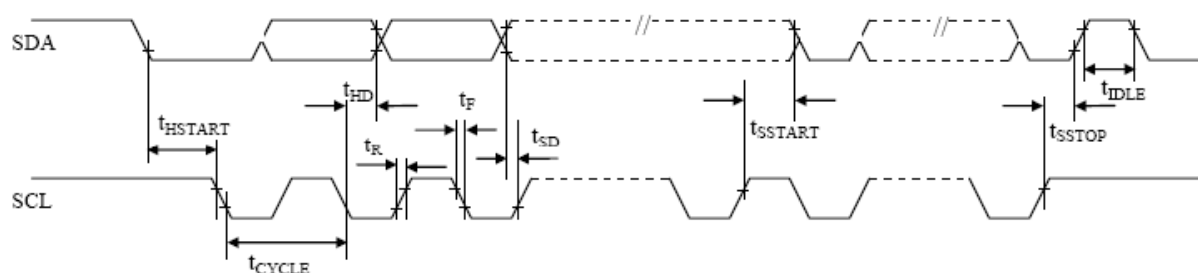

Product No.	DD-12864YO-3A	REV. D

Page	15 / 27
------	---------

## 4 OPTICAL SPECIFICATION

### 4.1 OPTICAL CHARACTERISTICS

Characteristics	Symbol	Condition	Min	Typ	Max	Unit
Brightness(White)	L <sub>br</sub>	With Polarizer (Note 3)	120	150	-	cd/m <sup>2</sup>
C.I.E.(White)	(X)	C.I.E 1931	0.44	0.48	0.52	-
	(Y)		0.46	0.50	0.54	
Dark Room Contrast	CR		-	>2000:1	-	-
Viewing Angle			>160	-	-	degree

Optical measurement taken at V<sub>DD</sub> = 2.8V, V<sub>CC</sub> = 12.5V.  
Software configuration follows Section 5.4 Initialization

Product No.	DD-12864YO-3A	REV. D

Page	16 / 27
------	---------



## 5 FUNCTIONAL SPECIFICATION

### 5.1 COMMANDS

Please refer to the Technical Manual for the SSD1305

### 5.2 POWER UP/DOWN SEQUENCE

To protect panel and extend the panel lifetime, the driver IC power up/down routine should include a delay period between high voltage and low voltage power sources during turn on/off. It gives the panel enough time to complete the action of charge and discharge before/after the operation.

#### 5.2.1 POWER UP SEQUENCE

1. Power up  $V_{DD}$
2. Send Display off command
3. Initialization
4. Clear Screen
5. Power up  $V_{CC}$
6. Delay 100ms  
(when  $V_{DD}$  is stable)
7. Send Display on command

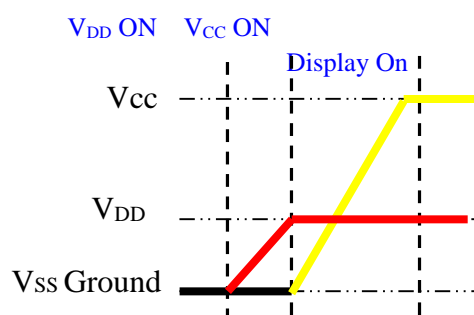

#### 5.2.2 POWER DOWN SEQUENCE

1. Send Display off command
2. Power down  $V_{CC}$
3. Delay 100ms  
(When  $V_{PP}$  reach 0 and panel is completely discharges)
4. Power down  $V_{DD}$

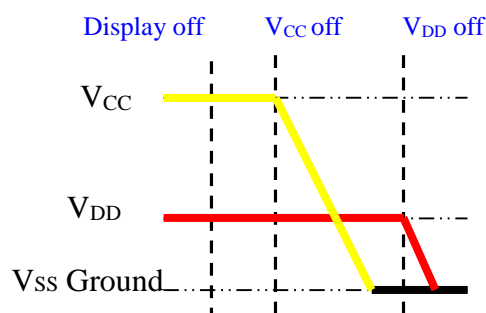

### 5.3 RESET CIRCUIT

When RES# input is low, the chip is initialized with the following status:

1. Display is OFF
2. 132x64 Display mode
3. Normal segment and display data column and row address mapping (SEG0 mapped to column address 00H and COM0 mapped to row address 00H)
4. Shift register data clear in serial interface
5. Display start line is set at display RAM address 0
6. Column address counter is set at 0
7. Normal scan direction of the COM outputs
8. Contrast control register is set at 80H
9. Normal display mode (Equivalent to A4h command)

Product No.	DD-12864YO-3A	REV. D

Page	17 / 27
------	---------

## 5.4 ACTUAL APPLICATION EXAMPLE

Command usage and explanation of an actual example

<Initialisation Setting>

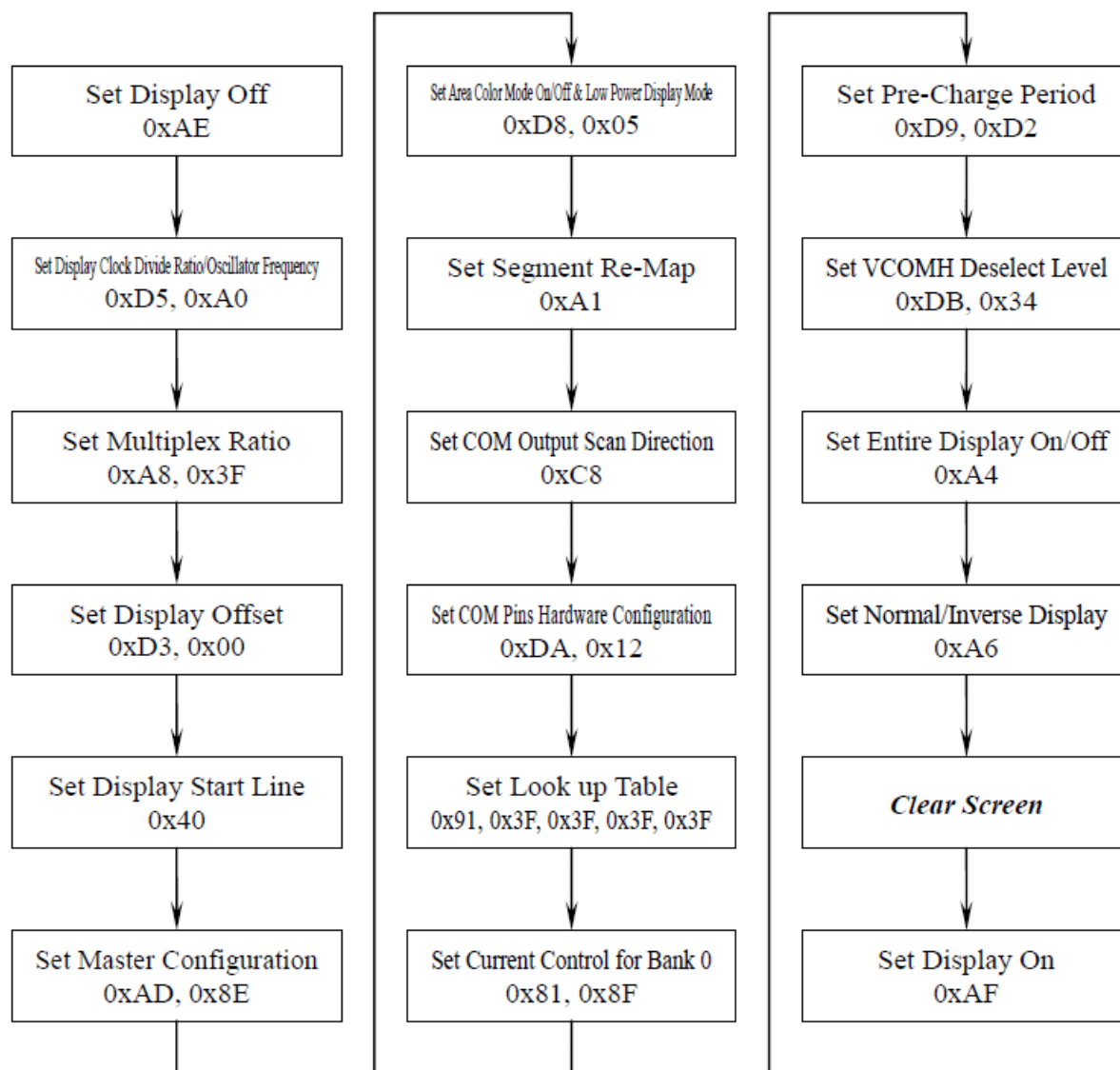

If the noise is accidentally occurred at the displaying window during the operation, please reset the display in order to recover the display function.

Product No.	DD-12864YO-3A	REV. D

Page	18 / 27
------	---------

54 Pieces per tray  
 15 trays per box ( 810 pieces )  
 4 boxes per carton (3240 pieces )

## 6 PACKAGING AND LABELLING SPECIFICATION

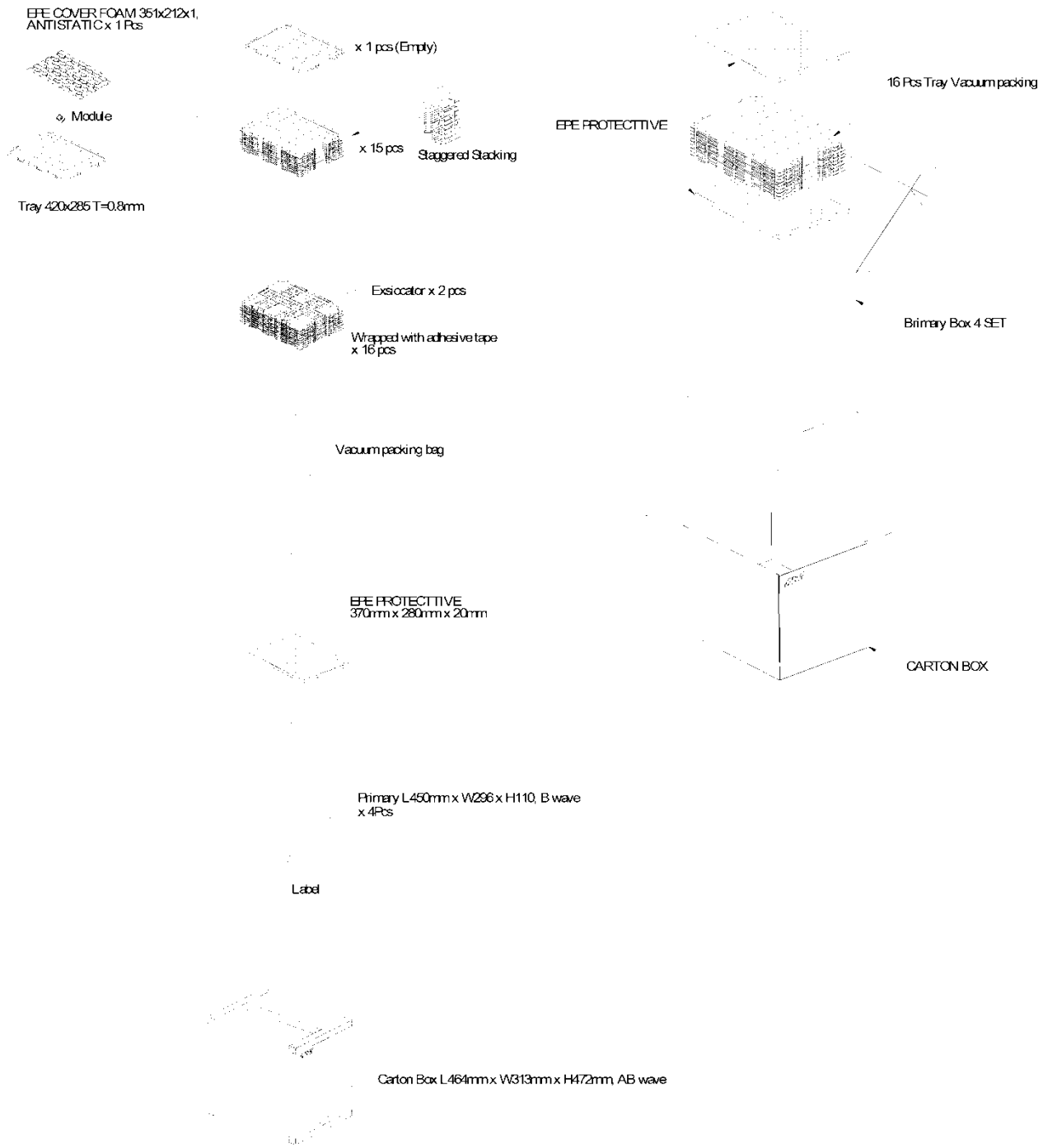

Product No.	DD-12864YO-3A	REV. D

Page	19 / 27
------	---------

## 7 QUALITY ASSURANCE SPECIFICATION

### 7.1 CONFORMITY

---

The performance, function and reliability of the shipped products conform to the Product Specification.

### 7.2 DELIVERY ASSURANCE

---

#### 7.2.1 DELIVERY INSPECTION STANDARDS

IPC-AA610, class 2 electronic assemblies standard

#### 7.2.2 Zone definition

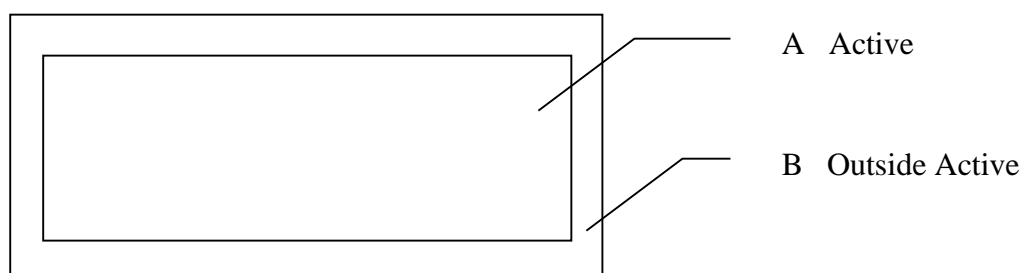

#### 7.2.3 Visual inspection

Test and measurement to be conducted under following conditions:

Temperature:	23±5°C
Humidity:	55±15%RH
Fluorescent lamp:	30 W
Distance between the Panel & Eyes of the Inspector:	≥30cm
Distance between the Panel & the lamp:	≥50cm

Product No.	DD-12864YO-3A	REV. D

Page	20 / 27
------	---------

### 7.2.4 Standard of appearance inspection

Units: mm

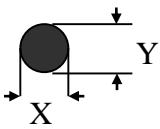
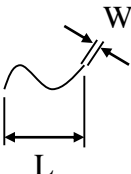
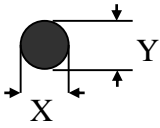
Class	Item	Criteria																																	
Minor	Packing & Label	Outside & inside package   Presence of product no., lot no., quantity																																	
Critical		Product must not be mixed with others and quantity must not be different from that indicated on the label																																	
Major	Dimension	Product dimensions must be according to specification and drawing																																	
Major	Electrical	Product electrical characteristics must be according to specification																																	
Critical	OLED Display	Missing lines, short circuits or wrong patterns on OLED display are not allowed																																	
Minor	Black spot, white spot, dust	<p>Round type: as per following drawing  <math>\varnothing = (X+Y)/2</math></p>  <table border="1" style="margin-left: auto; margin-right: auto;"> <thead> <tr> <th colspan="3">Acceptable quantity</th> </tr> <tr> <th>Size</th> <th>Zone A</th> <th>Zone B</th> </tr> </thead> <tbody> <tr> <td><math>\varnothing &lt; 0.1</math></td> <td>Any number</td> <td rowspan="4">Any number</td> </tr> <tr> <td><math>0.1 &lt; \varnothing &lt; 0.2</math></td> <td>3</td> </tr> <tr> <td><math>0.2 &lt; \varnothing &lt; 0.25</math></td> <td>1</td> </tr> <tr> <td><math>0.25 &lt; \varnothing</math></td> <td>0</td> </tr> </tbody> </table> <p>Line type: as per following drawing</p>  <table border="1" style="margin-left: auto; margin-right: auto;"> <thead> <tr> <th colspan="4">Acceptable quantity</th> </tr> <tr> <th>Length</th> <th>Width</th> <th>Zone A</th> <th>Zone B</th> </tr> </thead> <tbody> <tr> <td>--</td> <td><math>W \leq 0.05</math></td> <td>Any number</td> <td rowspan="3">Any number</td> </tr> <tr> <td><math>L \leq 2.0</math></td> <td><math>W \leq 0.1</math></td> <td>3</td> </tr> <tr> <td><math>L &gt; 2.0</math></td> <td></td> <td>0</td> </tr> </tbody> </table> <p style="text-align: center;">Total acceptable quantity: 3</p>	Acceptable quantity			Size	Zone A	Zone B	$\varnothing < 0.1$	Any number	Any number	$0.1 < \varnothing < 0.2$	3	$0.2 < \varnothing < 0.25$	1	$0.25 < \varnothing$	0	Acceptable quantity				Length	Width	Zone A	Zone B	--	$W \leq 0.05$	Any number	Any number	$L \leq 2.0$	$W \leq 0.1$	3	$L > 2.0$		0
Acceptable quantity																																			
Size	Zone A	Zone B																																	
$\varnothing < 0.1$	Any number	Any number																																	
$0.1 < \varnothing < 0.2$	3																																		
$0.2 < \varnothing < 0.25$	1																																		
$0.25 < \varnothing$	0																																		
Acceptable quantity																																			
Length	Width	Zone A	Zone B																																
--	$W \leq 0.05$	Any number	Any number																																
$L \leq 2.0$	$W \leq 0.1$	3																																	
$L > 2.0$		0																																	
Minor	Polariser scratch	Scratch on protective film is permitted Scratch on polariser: same as No. 1																																	
Minor	Polariser bubble	<p><math>\varnothing = (X+Y)/2</math></p>  <table border="1" style="margin-left: auto; margin-right: auto;"> <thead> <tr> <th colspan="3">Acceptable quantity</th> </tr> <tr> <th>Size</th> <th>Zone A</th> <th>Zone B</th> </tr> </thead> <tbody> <tr> <td><math>\varnothing &lt; 0.5</math></td> <td>Any number</td> <td rowspan="2">Any number</td> </tr> <tr> <td><math>\varnothing &gt; 0.5</math></td> <td>0</td> </tr> </tbody> </table>	Acceptable quantity			Size	Zone A	Zone B	$\varnothing < 0.5$	Any number	Any number	$\varnothing > 0.5$	0																						
Acceptable quantity																																			
Size	Zone A	Zone B																																	
$\varnothing < 0.5$	Any number	Any number																																	
$\varnothing > 0.5$	0																																		

Product No.	DD-12864YO-3A	REV. D

Page	21 / 27
------	---------

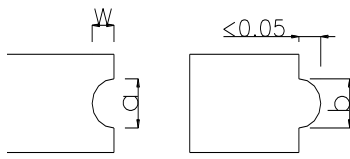
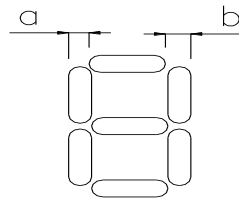
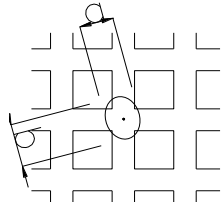
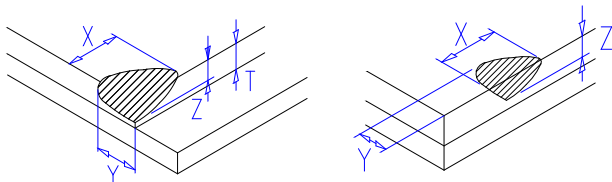
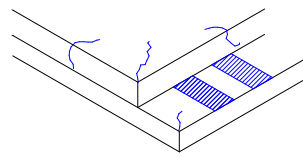
Class	Item	Criteria																												
Minor	Segment deformation	<p>1b. Pin hole on dot matrix display</p>  <table border="1" data-bbox="1021 336 1420 526"> <thead> <tr> <th colspan="2">Acceptable quantity</th> </tr> <tr> <th>Size</th> <th></th> </tr> </thead> <tbody> <tr> <td><math>a, b &lt; 0.1</math></td> <td>Any number</td> </tr> <tr> <td><math>(a+b)/2 \le 0.1</math></td> <td>Any number</td> </tr> <tr> <td><math>0.5 &lt; \varnothing &lt; 1.0</math></td> <td>3</td> </tr> </tbody> </table> <p>Total acceptable quantity: 7</p> <p>2. Segments / dots with different width</p>  <table border="1" data-bbox="1021 728 1420 840"> <thead> <tr> <th colspan="2">Acceptable</th> </tr> </thead> <tbody> <tr> <td><math>a \geq b</math></td> <td><math>a/b \leq 4/3</math></td> </tr> <tr> <td><math>a &lt; b</math></td> <td><math>a/b &gt; 4/3</math></td> </tr> </tbody> </table> <p>3. Alignment layer defect</p> <p><math>\varnothing = (a+b)/2</math></p>  <table border="1" data-bbox="1021 907 1420 1131"> <thead> <tr> <th colspan="2">Acceptable quantity</th> </tr> <tr> <th>Size</th> <th></th> </tr> </thead> <tbody> <tr> <td><math>\varnothing \leq 0.4</math></td> <td>Any number</td> </tr> <tr> <td><math>0.4 &lt; \varnothing \leq 1.0</math></td> <td>5</td> </tr> <tr> <td><math>1.0 &lt; \varnothing \leq 1.5</math></td> <td>3</td> </tr> <tr> <td><math>1.5 &lt; \varnothing \leq 2.0</math></td> <td>2</td> </tr> </tbody> </table> <p>Total acceptable quantity: 7</p>	Acceptable quantity		Size		$a, b < 0.1$	Any number	$(a+b)/2 \le 0.1$	Any number	$0.5 < \varnothing < 1.0$	3	Acceptable		$a \geq b$	$a/b \leq 4/3$	$a < b$	$a/b > 4/3$	Acceptable quantity		Size		$\varnothing \leq 0.4$	Any number	$0.4 < \varnothing \leq 1.0$	5	$1.0 < \varnothing \leq 1.5$	3	$1.5 < \varnothing \leq 2.0$	2
Acceptable quantity																														
Size																														
$a, b < 0.1$	Any number																													
$(a+b)/2 \le 0.1$	Any number																													
$0.5 < \varnothing < 1.0$	3																													
Acceptable																														
$a \geq b$	$a/b \leq 4/3$																													
$a < b$	$a/b > 4/3$																													
Acceptable quantity																														
Size																														
$\varnothing \leq 0.4$	Any number																													
$0.4 < \varnothing \leq 1.0$	5																													
$1.0 < \varnothing \leq 1.5$	3																													
$1.5 < \varnothing \leq 2.0$	2																													
Minor	Panel Chipping	<p><math>X \leq 1/6</math> Panel length  <math>Y \leq 1</math>  <math>Z \leq T</math></p> 																												
Minor	Panel Cracking	<p>Cracks not allowed</p> 																												
Minor	Copper exposed (pin or film)	Not allowed if visible by eye inspection																												
Minor	Film or Trace Damage	Not allowed if affect electrical function																												

Product No.	DD-12864YO-3A	REV. D

Page	22 / 27
------	---------

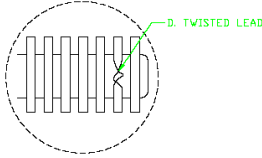
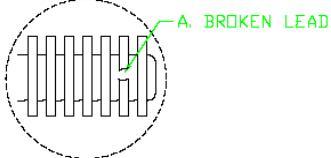
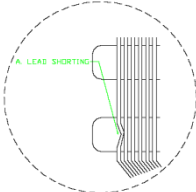
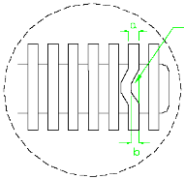
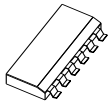
Class	Item	Criteria			
Minor	Contact Lead Twist	Not allowed			
Minor	Contact Lead Broken	Not allowed			
Minor	Contact Lead Bent	Not allowed if bent lead causes short circuit			
		Not allowed if bent lead extends horizontally more than 50% of its width			
Minor	Colour uniformity	Level of sample for approval set as limit sample			
Major		No unmelted solder paste should be present on PCB			
Critical		Cold solder joints, missing solder connections, or oxidation are not allowed			
Minor		No residue or solder balls on PCB are allowed			
Critical		Short circuits on components are not allowed			
Minor	Tray particles		Size	Quantity	
			On tray	$\varnothing < 0.2$	Any number
				$\varnothing > 0.25$	4
			On display	$\varnothing \geq 0.25$	2
$L = 3$	1				

Product No.	DD-12864YO-3A	REV. D

Page	23 / 27
------	---------

## **7.3 DEALING WITH CUSTOMER COMPLAINTS**

---

### **7.3.1 Non-conforming analysis**

Purchaser should supply Densitron with detailed data of non-conforming sample.  
 After accepting it, Densitron should complete the analysis in two weeks from receiving the sample.  
 If the analysis cannot be completed on time, Densitron must inform the purchaser.

### **7.3.2 Handling of non-conforming displays**

If any non-conforming displays are found during customer acceptance inspection which Densitron is clearly responsible for, return them to Densitron.  
 Both Densitron and customer should analyse the reason and discuss the handling of non-conforming displays when the reason is not clear.  
 Equally, both sides should discuss and come to agreement for issues pertaining to modification of Densitron quality assurance standard.

Product No.	DD-12864YO-3A	REV. D

Page	24 / 27
------	---------



## 8 RELIABILITY SPECIFICATION

### 8.1 RELIABILITY TESTS

Test Item	Test Condition	Evaluation and assessment
High Temperature Operation	85°C, 500 hours	No abnormalities in function and appearance
Low Temperature Operation	-30°C, 500 hours	No abnormalities in function and appearance
High Temperature Storage	90°C, 500 hours	No abnormalities in function and appearance
Low Temperature Storage	-40°C, 500 hours	No abnormalities in function and appearance
High Temperature & High Humidity Storage(Operation)	60°C, 90%RH, 240 hours	No abnormalities in function and appearance
Thermal Shock	-40°C 85°C, 100 cycles 30 mins dwell	No abnormalities in function and appearance

- The samples used for above tests do not include polarizer.
- No moisture condensation is observed during tests.

#### 8.1.1 FAILURE CHECK STANDARD

After the completion of the described reliability test, the samples were left at room temperature for 2 hrs prior to conducting the failure test at 23±5 °C; 55±15% RH

### 8.2 LIFE TIME

Item	Description
1	Function, performance, appearance, etc. shall be free from remarkable deterioration more than 10,000 hours under 150 cd/m <sup>2</sup> brightness and 40,000 hours under 100 cd/m <sup>2</sup> brightness at 50% Checkerboard, humidity (50% RH), and in area not exposed to direct sunlight.
2	End of lifetime is specified as 50% of initial brightness.

Product No.	DD-12864YO-3A	REV. D

Page	25 / 27
------	---------

## 9 HANDLING PRECAUTIONS

### *Safety*

If the panel breaks, be careful not to get the organic substance in your mouth or in your eyes.

If the organic substance touches your skin or clothes, wash it off immediately using soap and plenty of water.

### *Mounting and Design*

Place a transparent plate (e.g. acrylic, polycarbonate or glass) on the display surface to protect the display from external pressure. Leave a small gap between the transparent plate and the display surface.

Design the system so that no input signal is given unless the power supply voltage is applied.

### *Caution during OLED cleaning*

Lightly wipe the display surface with a soft cloth soaked with Isopropyl alcohol, Ethyl alcohol or Trichlorotrifluoroethane.

Do not wipe the display surface with dry or hard materials that will damage the polariser surface.

Do not use aromatic solvents (toluene and xylene), or ketonic solvents (ketone and acetone).

### *Caution against static charge*

As the display uses C-MOS LSI drivers, connect any unused input terminal to  $V_{DD}$  or  $V_{SS}$ . Do not input any signals before power is turned on.

Also, ground your body, work/assembly table and assembly equipment to protect against static electricity.

### *Packaging*

Displays use OLED elements, and must be treated as such. Avoid strong shock and drop from a height.

To prevent displays from degradation, do not operate or store them exposed directly to sunshine or high temperature/humidity.

### *Caution during operation*

It is indispensable to drive the display within the specified voltage limit since excessive voltage shortens its life.

### *Other Precautions*

When a display module is operated for a long of time with fixed pattern may remain as an after image or slight contrast deviation may occur.

Nonetheless, if the operation is interrupted and left unused for a while, normal state can be restored.

Also, there will be no problem in the reliability of the module.

### *Storage*

Store the display in a dark place where the temperature is  $25^{\circ}\text{C} \pm 10^{\circ}\text{C}$  and the humidity below 50%RH.

Store the display in a clean environment, free from dust, organic solvents and corrosive gases.

Do not crash, shake or jolt the display (including accessories).

Product No.	DD-12864YO-3A	REV. D

Page	26 / 27
------	---------

## 10 SUPPORTED ACCESSORIES

### 10.1 DUO KIT

---

Densitron has developed an easy to use yet powerful development and demonstration tool for driving its range of Passive Matrix OLED displays from the USB port of a PC.

DUO (Densitron USB OLED) kit is hot pluggable and does not require extra cables or power supply to run, allowing users to be up and running in minutes.

The kit consists of an OLED display with transition Board, USB controller card, mini USB cable and a CD with software application and drivers.



**Part number: PDK-N-12864YO-3A**

### 10.2 TRANSITION BOARD CARD

---

A Transition board card is like a daughterboard which is meant to be a circuit board for connections between the baseboards (DUO).

It has connector pins for interfacing between the display and the baseboards.

It also includes the OLED display.

**Part number: PDT-N-12864YO-3A**

### 10.3 CONNECTOR BOARD CARD

---

A Connector board is a daughterboard which allows a connection between customer's microprocessor or microcontroller (customer's system) to the display.

**Part number: EVK-CONNECT-015**

### 10.4 CONNECTOR

---

Type: ZIF connector

No. of connections	Pitch (mm)	Manufacturer	Manufacturer part no.	Distributor part no.
24	0.50	Omron	XF2M-2415-1A	Farnell/1112559 Digikey/ OR721CT-ND

Product No.	DD-12864YO-3A	REV. D

Page	27 / 27
------	---------